

USER'S GUIDE

Installation & Operation
Instructions

Portable Doppler Flow Meter

Model PDFM 5.0

Manual Series A.1.7

Note: This page has been left blank intentionally.

INDEX

BATTERY	4
CONNECTIONS	4
KEYPAD SYSTEM	5
CALIBRATION MENU	6
MESSAGE.....	7
STATUS	7
PASSWORD.....	8
UNITS/MODE.....	9
CALIBRATION	10
DATA LOGGING	11
SPECIAL FUNCTIONS.....	12
SENSOR MOUNTING LOCATION.....	14
FIELD TROUBLESHOOTING	18
COMMON QUESTIONS AND ANSWERS	20
APPLICATIONS HOTLINE.....	22
PRODUCT RETURN PROCEDURE.....	23
FLOW METER DATA SHEET	24
LIMITED WARRANTY	25
SPECIFICATIONS.....	26
APPENDIX A - CONVERSION TABLE.....	28
PIPE CHARTS	29

IMPORTANT NOTE: This instrument is manufactured and calibrated to meet product specifications. Please read this manual carefully before installation and operation. Any unauthorized repairs or modifications may result in a suspension of the warranty.

If this product is not used as specified by the manufacturer, protection may be impaired.

Available in Adobe Acrobat pdf format

BATTERY

- A built-in rechargeable NiMH battery supplies power for 18 hours continuous operation when fully charged.
- Display brightness is adjustable to conserve power.
- State of charge is shown for normal use, sleep mode and charging.
- When switched OFF with the AC power module connected the flashing battery indicates charging, solid battery shows fully charged.
- The PDFM 5.0 will switch off automatically when the battery is fully discharged.
- Full charge requires approximately 6 hours charging.
- Sleep mode extends battery life for long term data logging. Maximum log time is 18 days at 5 minute sample rate.

CONNECTIONS

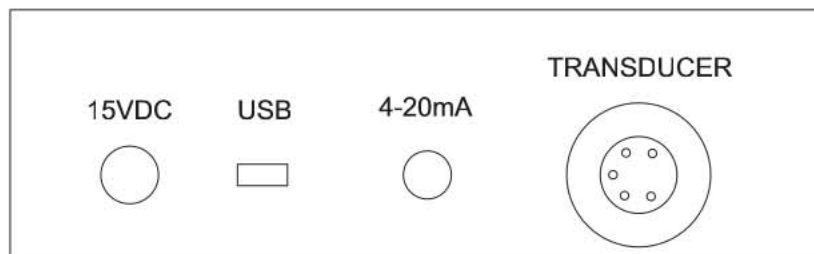

TRANSDUCER:

Use type PSE4 supplied with 12 ft (4 m) cable. Optional 50 ft (15 m) extension cable available.

4-20mA

Active only when powered by AC charger, maximum load 500 ohm.

USB

Cable Part #USB-PD is supplied for connecting the PDFM 5.0 to a PC or laptop.

POWER

An AC powered 15 volt DC power module is supplied for battery charging and continuous use.

KEYPAD SYSTEM.

The following diagram shows the PDFM 5.0 menu system. Arrows show the four directions to leave a menu box. Pressing a corresponding keypad arrow will move to the next item in the direction shown. Move the cursor (underline) under numerals and increase or decrease numerals with the **↑** and **↓** keys.

To store calibration values permanently, press the **✓**.



CALIBRATION MENU

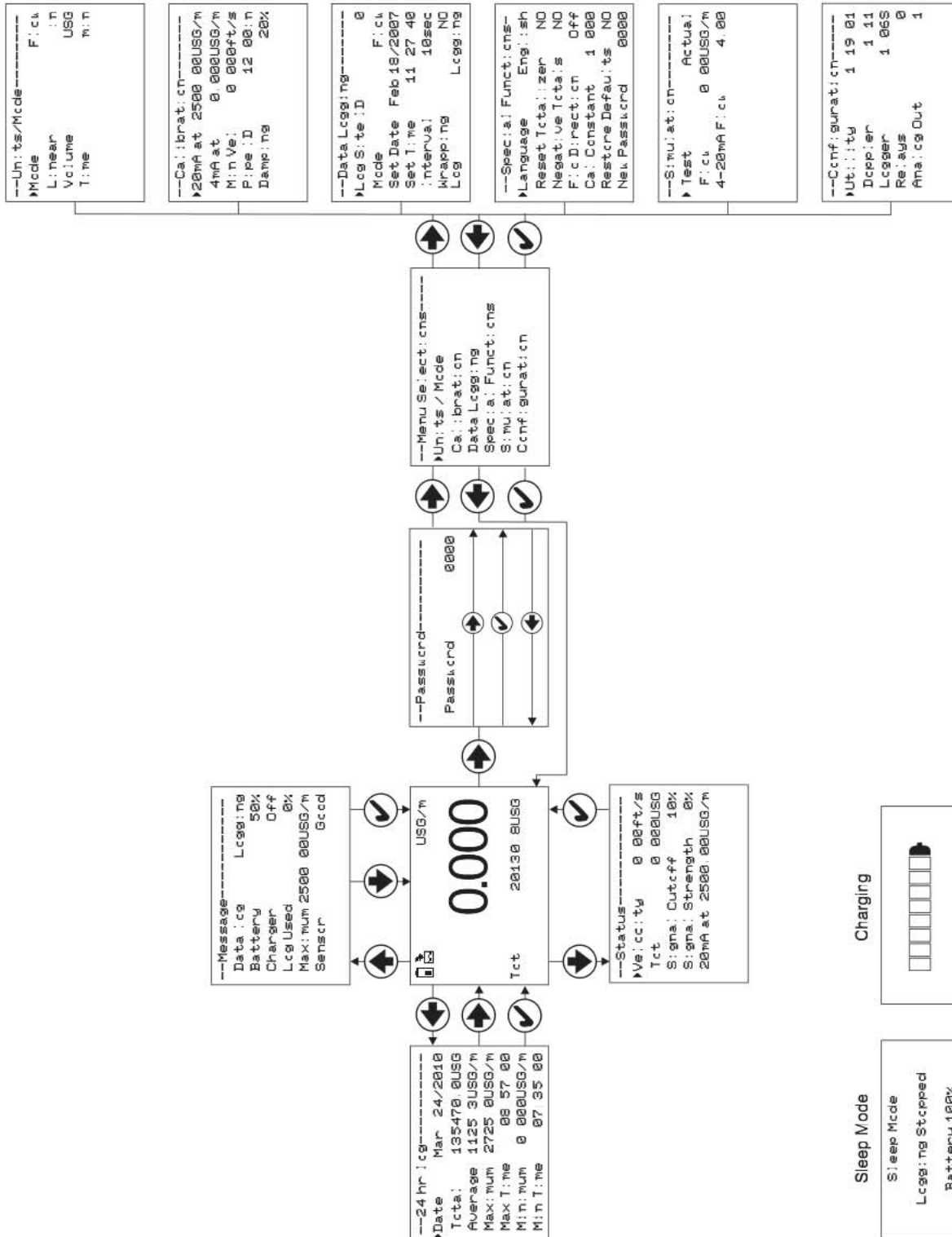



RUN

The main display shows the units selected from the Units/Mode menu, Flow or Velocity rate being measured, TOTALIZER. The PDFM 5.0 will start-up with this display and will return to this screen after a timeout if keys are not pressed in other menus.



Message is waiting. (Animated)



Battery

0%



Battery

25%



Battery

50%



Battery

75%



Battery

100%

(Animated when charging)



Unit plugged into charger.



Data logging isoff.



Data logging ison. (Animated)

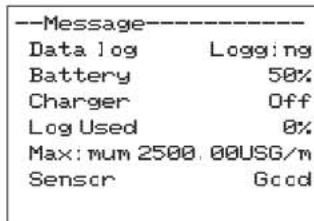

MESSAGE

Press **↑** from the RUN display to view error/warning messages provided by the instrument. The Message icon will appear on the RUN display if error messages are being generated by the instrument. Press **✓** to return to the main display.

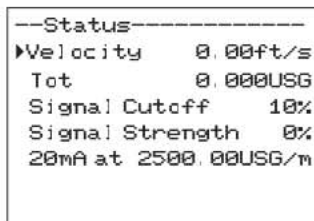

STATUS

Press **↓** from the RUN display to view instrument status. Velocity will be displayed in ft/sec or m/sec.

- Tot** Displays the current totalizer reading.
- Signal Cutoff** Adjust the setting in percent to suppress flow readings at zero flow when fluid swirling or pipe vibration may cause the instrument to continue reading. Example: Signal Cutoff at 5% will force the display and outputs to zero when signal strength drops below 5%.
- Signal Strength** Displays percentage of signal being received by the ultrasonic sensor.
- 20mA at** Displays the flow rate set as 20mA in the Calibration menu. Press **✓** to return to the main display.

```

--Units/Mode-----
▶Mode           Flow
Linear          in
Volume          USG
Time            min
    
```

UNITS/MODE.

From ▶Mode press the ➡ and then the ⬆ or ⬇ to select Flow or Velocity. Flow mode displays the flow rate in engineering units (e.g. gpm, litres/sec, etc.) Press the ✓ to store your selection then the ⬇ to the next menu item and ➡ to enter.

```

--Units/Mode-----
Mode           Flow
▶Linear        in
                ft
                m
                mm
    
```

From ▶Linear press the ➡ key and then the ⬆ or ⬇ to select your units of measurement. Press the ✓ to store your selection.

Press the ⬇ key to move the ▶ symbol to each subsequent menu item and the ✓ to save your selections.

Note: the volume selection "bbl" denotes U.S. oil barrel.

```

--Units/Mode-----
▶Volume        USG
                ft3
                bbl
                L
                m3
                lMG
                lG
                USMG
    
```

Press ⬅ or ✓ to return to the Menu Selections screen.

```

--Units/Mode-----
Mode           Flow
Linear          in
Volume          USG
▶Time           sec
                day
                hr
                min
    
```

```
--Calibration-----
▶20mA at 2500.00USG/m
4mA at 0.000USG/m
Min Vel 0.000ft/s
Pipe ID 12.00in
Damping 20%
```

CALIBRATION

Press the **↓** to **▶Calibration** and **▶** to enter. Use **↓** or **↑** to position **▶** before each menu item and **▶** to enter. When settings are completed press **✓** to store and return to the **Calibration** menu.

- *20mA at** Press **▶** then **↓** or **↑** to change the numbers and decimal point. Use this menu to set the corresponding flow rate that will be represented by 20mA analog output. If maximum flow is unknown, enter an estimated flow rate and observe actual flow to determine the correct maximum value. Any velocity or flow rate up to +40 ft/sec (12.2 m/sec) may be selected.
- *4mA at** Press **↓** or **↑** to set the flow rate corresponding to 4mA analog output. This setting may be left at zero flow (or velocity or can be raised to any value less than the 20mA setting, or lowered to any velocity or corresponding flow rate down to -40 ft/sec (-12.2 m/sec).
- Min Vel** Press **▶** and enter a minimum velocity cutoff. Forward and reverse velocities less than **Min Vel** will be forced to zero.
- Pipe ID** Place the cursor under the digits and then **↓** or **↑** to change the numbers and decimal point. **Pipe ID** should be entered as the exact inside diameter of the pipe where the sensor is mounted. Refer to the Pipe Charts Appendix in this manual for inside diameter of common pipe types and sizes.
- Damping** Increase damping to stabilize readings under turbulent flow conditions. Decrease for fast response to small changes in flow. Damping is shown in percentage (maximum is 99%). Factory default is 20%.

Press **✓** from the **Units/Mode** display to return to **Menu Selections**.

***Note** 4-20mA circuitry is only powered by the AC power module. To conserve power this output is not active in battery power mode.

```
--Data Logging-----
Log Site ID      0
Set Date   Feb 18/2007
Set Time    11:27:48
Interval    10sec
Wrapping    NO
Log         Logging
```

DATA LOGGING

Setup

Select `Data Logging` from Menu Selections.

- Log Site ID** Enter a number from 00 to 99. The site ID will become part of the downloaded file name to help distinguish downloads from different instruments. Press \checkmark to store the setting.
- Set Date** Press \uparrow or \downarrow to scroll and select Month, Day and Year. Press \checkmark to store the setting.
- Set Time** Press \uparrow or \downarrow to select the current time in Hours, Minutes and Seconds. Press \checkmark to store the setting.
- Interval** Press \uparrow or \downarrow to select the logging interval. Flow rate reading will be stored at each time interval. Press \checkmark to store the setting.
- Wrapping** Press \uparrow or \downarrow to select `YES`. Press \checkmark to store the setting. This enables the logging wrap function. In `Wrapping` mode the *oldest* data will be overwritten by the *newest*. If `Wrapping` is not enabled the logger will stop when its memory becomes full.
- Log** Select `Delete` and then `Start` to apply any changes that have been made to the logger `Interval` or `Mode`. The current log file will be erased from memory and a new log file will start.

RETRIEVE LOG FILE

Install Greyline Logger on your PC or laptop. Refer to the Help menu in the program for detailed instructions.

- Connect the PDFM 5.0 to the PC using the supplied USB cable.
- Install the USB driver program from the install CD.
- Start the Greyline Logger Software.
- Select "xxxx scan for USB instruments xxxx" in the drop down window at the top of the main window. PDFM 5.0 will be indicated.
- Click the download icon to start transferring data.
- Downloaded data appears in a pop-up window.

--Special Functions--	
▶Language	English
Reset Totalizer	NO
Negative Totals	NO
Flow Direction	Off
Cal Constant	1.000
Restore Defaults	NO
New Password	0000

SPECIAL FUNCTIONS

Language	Select English, French or Spanish
Reset Totalizer	Press ➡ and select Yes to erase and restart the totalizer at zero.
Negative Totals	Select Yes to have reverse flow readings deducted from the totalizer. Select NO to totalize forward flow only and ignore reverse flow.
Reverse Flow	Select Yes to change the display from positive to negative values.
Cal Constant	Set to 1.000 for SE4-A transducer. (Note: Different transducer models require specific Cal Constants.)
Restore Defaults	Select Yes and press ✓ to erase all user settings and return the instrument to factory default settings.
New Password	Select any number from 0000 to 9999 and press ✓ . Default setting of 0000 will allow direct access to the calibration menus. Setting of any password greater than 0000 will require the password to be entered to access the calibration menus.

Press **✓** to return to **Menu Selections**.

--Simulation-----	
▶ Test	Actual
Flow	0.00USG/m
4-20mA Flow	4.00

SIMULATION

Exercises the 4-20mA.

Test Select **Maximum** and press ✓ to simulate maximum Flow or Velocity and to output 20mA to the analog channel.

Select **Minimum** and press ✓ to simulate minimum Flow or Velocity and to output 4mA to the analog channel.

To simulate measurements between minimum and maximum set **Test** to **Actual** and then enter for the flow measurement. The analog output will respond to the simulated value.

SLEEP MODE

Logging in sleep mode requires a minimum sample time of 30 seconds. Selecting sleep mode for 10 second sampling rate is indicated by a flashing display.

BACKLIGHT

Three levels of backlight are selectable to conserve power.

CHARGING

A flashing battery indicates charging.
A solid battery indicates fully charged.

SENSOR MOUNTING LOCATION

The position of the sensor is one of the most important considerations for accurate Doppler flow measurement. The same location guidelines apply to Doppler as most other types of flow meters.

Before permanently mounting a Doppler sensor onsite testing is recommended to determine optimum mounting position. Use the sensor coupling compound (supplied with each Greyline flow meter, or petroleum gel, acoustic compound or electrocardiograph gel). Take several readings around the axis of the pipe and then at several points upstream and downstream from the selected position, checking for consistent readings. Avoid high or low reading areas. Mount the sensor where consistent (average) readings were obtained or continue testing on another pipe section.

VERTICAL OR HORIZONTAL PIPE - Vertical pipe runs generally provide evenly distributed flow. On Horizontal pipes and liquids with high concentrations of gas or solids, the sensor should be mounted on the side (3 or 9 o'clock position) to avoid concentrations of gas at the top of the pipe, or solids at the bottom. For liquids with minimal gas bubbles (e.g. potable water) the sensor should be mounted on the top of a horizontal pipe (12 o'clock position) to obtain the best signal strength.

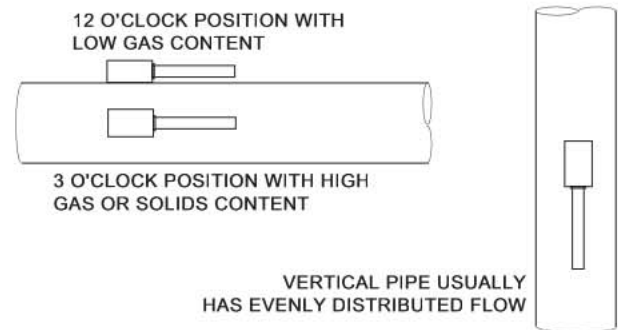

VELOCITY INCREASING DEVICES: Generally the sensor must be mounted away from flow disturbances such as valves, pumps, orifice plates, venturis or pipe inlets and discharges which tend to increase flow velocity. Velocity increasing devices often cause cavitation, or rapid release of gas bubbles, and readings both up and downstream may show much higher velocity. As a guideline, mount the sensor at least 20 diameters upstream or 30 diameters downstream from velocity increasing devices.

Required distance from a velocity increasing device will vary in applications depending on the flow velocity and the characteristics of the liquid itself.

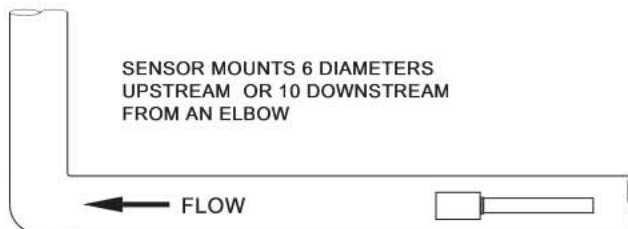

TURBULENCE INCREASING DEVICES: Elbows, flanged connections and tees tend to introduce desirable conditions of an evenly distributed flow profile with some air or gases entrained in the flow. Sensor mounting 6 pipe diameters upstream and 10 diameters downstream from these disturbances is generally optimum.

The sensor is designed to mount longitudinally on a straight section of pipe. Do not attempt to mount it on bends, elbows or fittings.

SENSOR MOUNTING

Prepare an area 2" wide by 4" long (50mm x 100mm) for sensor bonding by removing loose paint, scale and rust. The objective of site preparation is to eliminate any discontinuity between the sensor and the pipe wall, which would prevent acoustical coupling.

A PC4 Sensor Mounting Kit is supplied with each Greyline flow meter. It includes recommended coupling compound in a plastic applicator and a stainless steel mounting bracket with adjustable pipe straps.

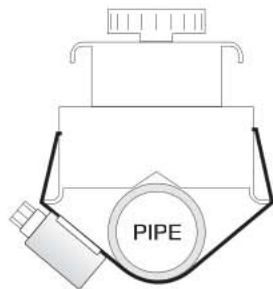

END VIEW

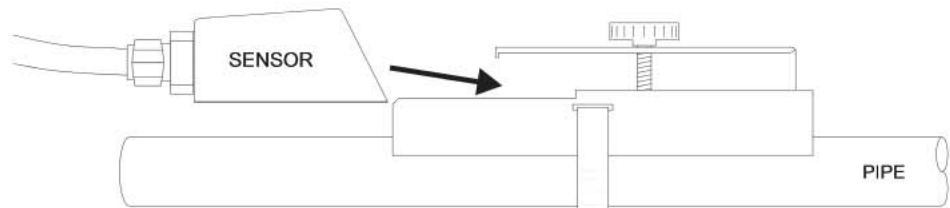

Mount the PC4 pipe clamp as illustrated on pipes 0.6" / 15 mm OD or larger. Stainless steel bands are included for mounting on pipes up to 32" / 81 cm OD.

Additional stainless steel bands (by customer) may be combined to mount on pipes up to 180" / 4.5 m OD.

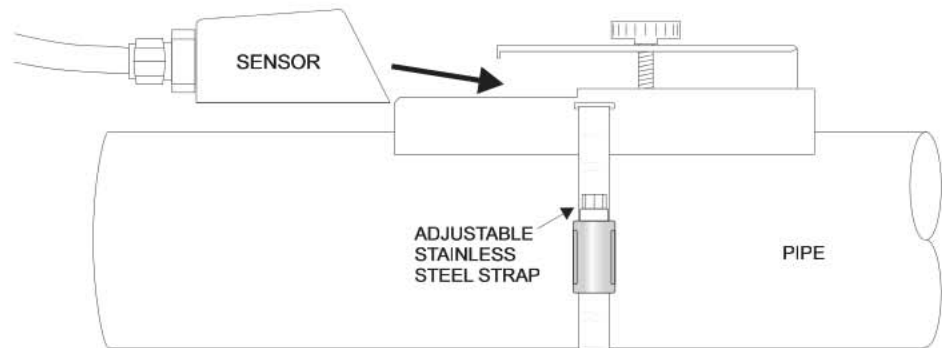
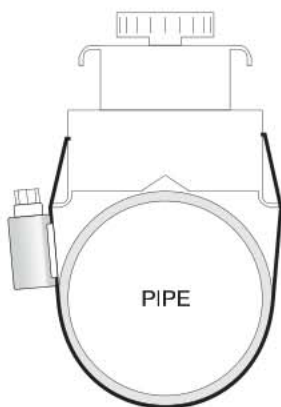

SENSOR COUPLING

For permanent or temporary bonding, the following are recommended:

- a) Dow Corning silicon compound #4 (supplied)
Additional supply: order Greyline Option CC
- b) High Temperature compound (supplied with Sensor Option SE3H)
Additional supply: order Greyline Option AP-1W
- c) Water-based sonic compound: Order Greyline Option CC30
- d) Electrocardiograph gel
- e) Petroleum gel (Vaseline)

The above are arranged in their order of preferred application.

d & e are only good for temporary bonding at room temperature.

DO NOT USE: Silicon RTV caulking compound (silicon rubber).

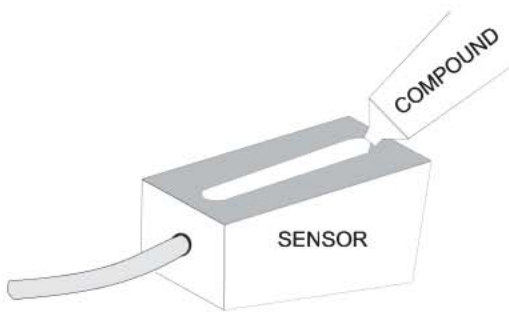

Use the PC4 pipe clamp (supplied) as illustrated above or use a loop of electrical tape for temporary mounting. Apply silicon coupling compound #4 to the coloured face of the sensor. A bead, similar to toothpaste on a toothbrush, is ideal. Do not overtighten (crush the sensor).

The sensor must be fixed securely to the pipe with coupling material between the sensor face and the pipe. Sensor installation with excessive coupling compound can result in gaps or voids in the coupling and cause errors or loss of signal. Insufficient coupling compound will create similar conditions.

Over time temporary coupling compounds (e.g. Petroleum Gel) may gradually sag away from the sensor resulting in reduced signal strength and finally complete loss of signal. Warm temperatures, moisture and vibration will accelerate this process. Dow Corning Silicone Compound #4 as supplied with the PDFM 5.0 (and available from Greyline Instruments) is recommended for semi-permanent installations.

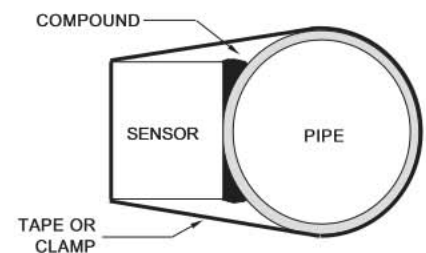

SENSOR MOUNTING/COUPLING RECOMMENDATIONS

BAD

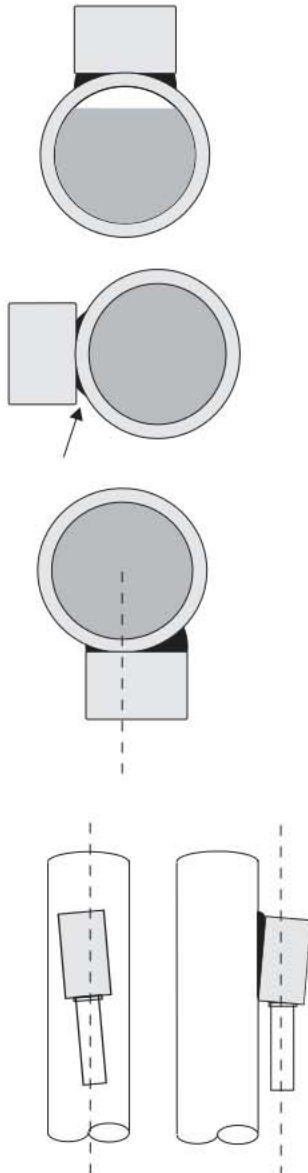

GOOD

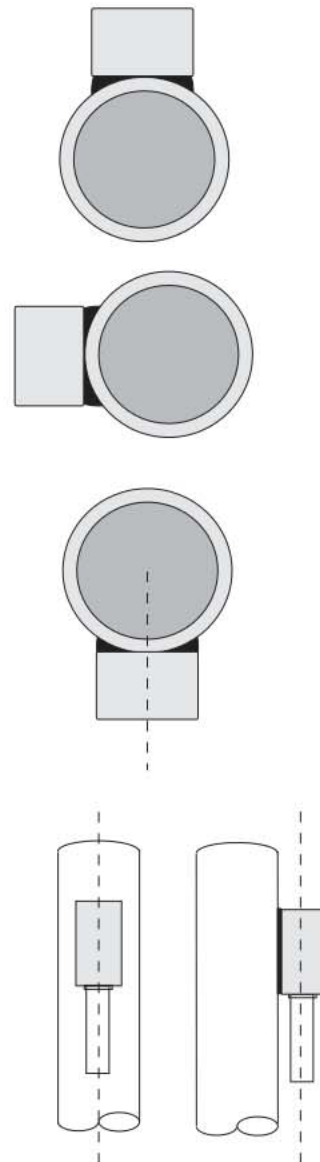

FIELD TROUBLESHOOTING

<i>Possible Causes:</i>	<i>Corrective Action:</i>
<i>METER READING LOWER THAN EXPECTED</i>	
Calibration Error	<ul style="list-style-type: none"> • Review UNITS/MODE menu and Pipe ID
Lower flow rate than expected	<ul style="list-style-type: none"> • Investigate pump/valves. Compare velocity with alternate instrument
Signal not penetrating far enough into the flow stream	<ul style="list-style-type: none"> • Relocate sensor closer to elbows or flow disturbances
Improper mounting of sensor	<ul style="list-style-type: none"> • Reinstall Sensor with careful application of Coupling Compound
Pipe is not full	<ul style="list-style-type: none"> • Remount Sensor on vertical pipe
<i>METER READING WHEN THERE IS NO FLOW</i>	
Vibration on pipe	<ul style="list-style-type: none"> • Adjust Status / Signal Cutoff setting • Install in another location
Variable Speed Drive interference	<ul style="list-style-type: none"> • Follow Drive manufacturers wiring and Grounding instructions • Relocate Flowmeter, Sensor and wiring away from VSD
Sensor connections incorrect	<ul style="list-style-type: none"> • Refer to Connections diagram
<i>METER READING ERRATIC</i>	
Sensor mounted too close to valve, pump or elbow	<ul style="list-style-type: none"> • Change sensor placement. Recommended 6-10 diameters from elbows, and 30 diameters from pumps, controlling valves, orifice plates, nozzles or open pipe discharge
<i>NO FLOW INDICATION</i>	
Not enough suspended particles or gases in the fluid	<ul style="list-style-type: none"> • Relocate sensor in more turbulent pipe section. Mount sensor at 12 o'clock position on horizontal pipe

<i>Possible Causes:</i>	<i>Corrective Action:</i>
Coupling compound washed out, or sensor loose on pipe	<ul style="list-style-type: none"> • Remount sensor • Use Dow Corning Silicone #4
<i>METER READING TOO HIGH</i>	
Calibration error	<ul style="list-style-type: none"> • Review UNITS/MODE menu and Pipe ID
Vibration or noise on the pipeline	<ul style="list-style-type: none"> • Install in another location.
Pipe is not full	<ul style="list-style-type: none"> • Remount Sensor on vertical pipe
Nearby velocity increasing device (pump, valve, orifice plate)	<ul style="list-style-type: none"> • Relocate sensor >30 pipe diameters from velocity increasing device
Variable Speed Drive interference	<ul style="list-style-type: none"> • Follow Drive manufacturers wiring and Grounding instructions • Relocate Flowmeter, Sensor and wiring away from VSD

COMMON QUESTIONS AND ANSWERS

The pipe vibrates. Will it affect the flow meter?

Common vibration frequencies are far lower than the sonic frequencies used by the Greyline flow meter, and will not normally affect accuracy or performance. However, applications where very weak Doppler signal is present (when sensitivity is adjusted to maximum and signal strength is low), accuracy may be affected by pipe vibration, or the flow meter may show readings under no-flow conditions. Attempt to relocate the sensor on a pipe section where vibration is reduced, or arrange pipe mounting brackets to reduce vibration at the sensor mounting location.

The flow meter must be installed in a high noise environment. Will this affect operation?

Greyline flow meters are designed to discriminate between environmental noise and the Doppler signal. High noise environments may affect the flow meter's performance where low signal strength and/or low flow velocities are being measured. Relocate the sensor in a more quiet environment if possible.

Will pipe corrosion affect accuracy of the flow meter?

Yes. Rust, loose paint etc. must be removed from the outside of the pipe to provide a clean mounting position when installing a Doppler sensor. Severe corrosion/oxidation on the inside of the pipe may prevent the Doppler signal from penetrating into the flow. If the pipe cannot be cleaned, a spool piece (PVC recommended) should be installed for sensor mounting.

What effect do pipe liners have on the flow meter?

The air gap between loose insertion liners and the pipe wall prevent the Doppler signal from entering the flow. Better results can be expected with bonded liners such as cement, epoxy or tar, however an on site test is recommended to determine if the application is suitable for a Doppler flow meter.

Why is Doppler only recommended for liquids containing suspended solids or gases?

The Doppler sensor transmits sound into the flow stream which must be reflected back to the sensor to indicate flow velocity. Gas bubbles or suspended solids act as reflectors for the Doppler signal. As a guideline, Greyline Doppler flow meters are recommended for liquids containing solids or bubbles with a minimum size of 100 microns and a minimum concentration of 75 ppm. Most applications (except potable, distilled or deionized water) will meet this minimum requirement.

Can the sensor be submerged in water?

Yes, for short periods of time or by accident, but it is not recommended for continuous operation. The sensor is constructed to withstand submersion to 10 psi without damage, but external liquid moving in contact with the sensor can be interpreted as flow and cause false readings.

What is the purpose of the Signal Strength Display?

Doppler signals of very low strength are not accepted or processed by the instrument. This feature assists in rejection of environmental noise and vibration. Use the display to evaluate signal strength in your application. Strong signals will increase in percentage to a maximum of 100% or greater.

Does the PDFM 5.0 require periodic recalibration?

No. PDFM 5.0 calibration does not drift over time. The solid state sensor has no moving parts to wear and affect calibration. The Doppler flow technique generates an ultrasonic signal proportional to the velocity of flow. All Greyline timing/counting circuits use crystal-controlled frequency references to eliminate any drift in the processing circuitry.

APPLICATIONS HOTLINE

For applications assistance, advice or information on any Greyline Instrument contact your Sales Representative, write to Greyline or phone the Applications Hotline below:

United States:	Tel: 315-788-9500	Fax: 315-764-0419
Canada:	Tel: 613-938-8956	Fax: 613-938-4857
Toll Free:	888-473-9546	
Email:	info@greyline.com	
Web Site:	www.greyline.com	

Greyline Instruments Inc.

Canada
16456 Sixsmith Drive
Long Sault, Ont. K0C 1P0

USA:
105 Water Street
Massena, NY 13662

PRODUCT RETURN PROCEDURE

Instruments may be returned to Greyline for service or warranty repair.

1 Obtain an RMA Number from Greyline -

Before shipping a product to the factory please contact Greyline by telephone, fax or email to obtain an RMA number (Returned Merchandise Authorization). This ensures fast service and correct billing or credit.

When you contact Greyline please have the following information available:

1. Model number / Software Version
2. Serial number
3. Date of Purchase
4. Reason for return (description of fault or modification required)
5. Your name, company name, address and phone number

2 Clean the Sensor/Product -

Important: unclean products will not be serviced and will be returned to the sender at their expense.

1. Rinse sensor and cable to remove debris.
2. If the sensor has been exposed to sewage, immerse both sensor and cable in a solution of 1 part household bleach (Javex, Clorox etc.) to 20 parts water for 5 minutes. Important: do not immerse plug end of sensor cable.
3. Dry with paper towels and pack sensor and cable in a sealed plastic bag.
4. Wipe the outside of the enclosure to remove dirt or deposits.
5. Return to Greyline for service.

3 Ship to Greyline -

After obtaining an RMA number please ship the product to the appropriate address below:

Canadian and International
Customers:

Greyline Instruments Inc.
16456 Sixsmith Drive
Long Sault, Ont. K0C 1P0

RMA#

USA
Customers:

Greyline Instruments Inc.
204 150th Avenue
Madeira Beach, FL 33708

RMA#

FLOW METER DATA SHEET

<p>Greyline Instruments Inc. 16456 Sixsmith Dr., Long Sault, Ont. K0C 1P0 Tel: 613-938-8956 / Fax: 613-938-4857 105 Water Street, Massena NY 13662 Tel: 315-788-9500 / Fax: 315-764-0419</p>	<p><i>Please complete and return this form to Greyline. It is important. We use this information to check our database for performance of Greyline flow meters in similar applications, and to provide advice and recommendations to you. Thanks for your cooperation.</i></p>
<p>Contact: _____ Title/Dept.: _____ Company: _____ Project: _____ Address: _____ Tel: _____ Fax: _____</p>	
<p>SENSOR: Model/Type: _____ Cable Length: _____ Elec. Class: _____ Type of Pump: _____ Distance from nearest Pump, Controlling Valve, Orifice or open Discharge: _____</p>	
<p>INSTRUMENT: Model/Type: _____ Power Input: _____ Calibrated Range: _____ Indication: _____ Operating Temp.: _____ Alarm: _____ Enclosure Class: _____ Pulse/Unit: _____ Elec. Class: _____ Output: _____</p>	
<p>SERVICE CONDITIONS: Pipe ID: _____ <input type="checkbox"/> Vertical <input type="checkbox"/> Horizontal Pipe Mat'l: _____ % Solids: _____ Fluid: _____ Material Build-up: _____ Oper. Flow: _____ Vibration: _____ Max. Flow: _____ Max. Pressure: _____ Min. Flow: _____ Max. Temp: _____</p>	
<p>Notes / Sketch Pipe Run:</p>	

LIMITED WARRANTY

Greyline Instruments warrants, to the original purchaser, its products to be free from defects in material and workmanship for a period of one year from date of invoice. Greyline will replace or repair, free of charge, any Greyline product if it has been proven to be defective within the warranty period. This warranty does not cover any expenses incurred in the removal and re-installation of the product.

If a product manufactured by Greyline should prove defective within the first year, return it freight prepaid to Greyline Instruments along with a copy of your invoice.

This warranty does not cover damages due to improper installation or handling, acts of nature, or unauthorized service. Modifications to or tampering with any part shall void this warranty. This warranty does not cover any equipment used in connection with the product or consequential damages due to a defect in the product.

All implied warranties are limited to the duration of this warranty. This is the complete warranty by Greyline and no other warranty is valid against Greyline. Some states do not allow limitations on how long an implied warranty lasts or limitation of incidental or consequential damages, so the above limitations or exclusions may not apply to you.

This warranty gives you specific legal rights, and you may also have other rights which vary from state to state.

Greyline Instruments Inc.

SPECIFICATIONS

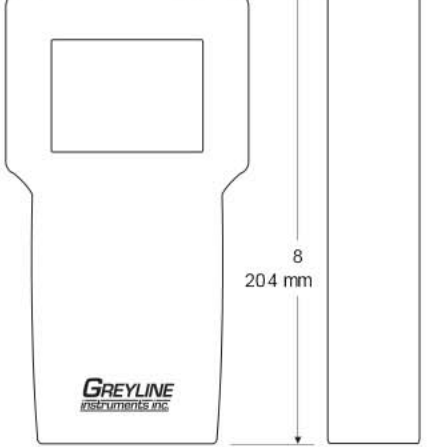
<p>Flow Rate Range: ± 0.1 to 40 ft/sec (± 0.03 to 12.2 m/sec) in most applications</p> <p>Pipe Size: Ultrasonic Sensor mounts on any pipe from 1/2" to 180" ID (12.5 mm to 4.5m)</p> <p>Display: White, backlit matrix - displays flow rate, totalizer, operating mode and calibration menu</p> <p>Power Input: Built-in NiMH battery for up to 18 hours continuous operation External charger with 100-240VAC 50/60Hz input</p> <p>Outputs: 4-20mA (500 ohm) when AC powered USB for Data Log transfer by direct PC connection</p> <p>Data Logger: Programmable 300,000 data point capacity, time and date stamped or formatted flow reports including total, average, minimum, maximum and times of occurrence</p> <p>PC Software: 'Greyline Logger' for Windows 98 or higher. Retrieves, displays and saves data log files</p> <p>Electronics Operating Temperature: -10° to 140°F (-23° to 60°C)</p> <p>Electronics Enclosure: Portable, ABS enclosure</p> <p>Carry Case: Rated IP67 with protective molded foam insert</p> <p>Accuracy: $\pm 2\%$ of full scale, requires solids or bubbles minimum size of 100 microns, minimum concentration 75 ppm. Repeatability: $\pm 0.25\%$, Linearity: $\pm 0.5\%$</p> <p>Calibration: Built-in 5-key programming with user-friendly calibration menu. Password protected.</p> <p>Language Selection: English, French, Spanish</p> <p>Sensitivity: Adjustable signal cut-off, signal strength and damping</p> <p>Approvals: Charger is CE and UL approved. The PDFM 5.0 is not certified for use in hazardous rated locations.</p>	 <p style="text-align: center;">ENCLOSURE</p>
---	---

PSE4 Doppler Sensor

Minimum Pipe Diameter:	0.5" (12.5 mm) ID, 0.6" (15 mm) OD
Maximum Pipe Diameter:	180" (4.5 m) ID
Operating Temperature:	-40° to 300°F (-40° to 150°C)
Operating Frequency:	640 KHz
Sensor Housing:	Stainless Steel
Sensor Cable:	12 ft. (3.66 m) shielded coaxial pair
Submersion Rating:	Withstands accidental submersion pressure up to 10 psi (0.7 Bar)

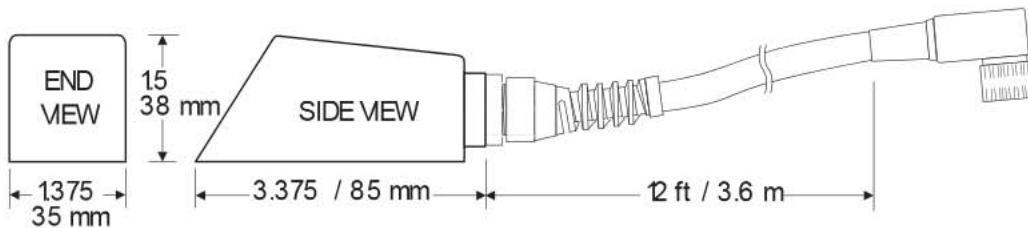

Options

Sensor Cable:	50 ft (15 m) sensor cable extension, shielded, with connectors
Sensor Mounting:	Extra silicone coupling compound. Additional stainless steel pipe clamps
Carrying Case:	Watertight carrying case with foam inserts

APPENDIX A - CONVERSION TABLE

CONVERSION GUIDE		
FROM	TO	MULTIPLY BY
US GALLONS	CUBIC FEET	0.1337
US GALLONS	IMPERIAL GALS	0.8327
US GALLONS	LITRES	3.785
US GALLONS	CUBIC METERS	0.003785
LITRES/SEC	GPM	15.85
LITRES	CUBIC METERS	0.001
BARRELS	US GALLONS	42
BARRELS	IMPERIAL GALS	34.9726
BARRELS	LITRES	158.9886
INCHES	MM	25.4
DEGREES F	DEGREES C	$(^{\circ}\text{F}-32) \times 0.556$
POUNDS	KILOGRAMS	0.453
PSI	BAR	0.0676
FOOT ²	METER ²	0.0929

Note: BARRELS are U.S. oil barrels.

PIPE CHARTS

Carbon Steel & PVC Pipe

Pipe Size	Pipe O.D.	Standard Schedule 40		Extra Heavy Schedule 80		Dbl. Extra Heavy		Schedule 10		Schedule 20		Schedule 30		Schedule 40	
		I.D.	WALL	I.D.	WALL	I.D.	WALL	I.D.	WALL	I.D.	WALL	I.D.	WALL	I.D.	WALL
1	.840	.622	.109	.546	.147	.252	.294							.622	.109
	1.050	.824	.113	.742	.154	.434	.308							.824	.113
1	1.315	1.049	.133	.957	.179	.599	.358							1.049	.133
1	1.660	1.380	.140	1.278	.191	.896	.382							1.380	.140
1	1.900	1.610	.145	1.500	.200	1.100	.400							1.610	.145
2	2.375	2.067	.154	1.939	.218	1.503	.436							2.067	.154
2	2.875	2.469	.203	2.323	.276	1.771	.552							2.469	.203
3	3.500	3.068	.216	2.900	.300	2.300	.600							3.068	.216
3	4.000	3.548	.226	3.364	.318	2.728	.636							3.548	.226
4	4.500	4.026	.237	3.826	.337	3.152	.674							4.026	.237
5	5.563	5.047	.258	4.813	.375	4.063	.750							5.047	.258
6	6.625	6.065	.280	5.761	.432	4.897	.864							6.065	.280
8	8.625	7.981	.322	7.625	.500	6.875	.875			8.125	.250	8.071	.277	7.981	.322
10	10.750	10.020	.365	9.750	.500	8.750	1.000			10.250	.250	10.136	.307	10.020	.365
12	12.750	12.000	.375	11.750	.500	10.750	1.000			12.250	.250	12.090	.330	11.938	.406
14	14.000	13.250	.375	13.000	.500			13.500	.250	13.376	.312	13.250	.375	13.124	.438
16	16.000	15.250	.375	15.000	.500			15.500	.250	15.376	.312	15.250	.375	15.000	.500
18	18.000	17.250	.375	17.000	.500			17.500	.250	17.376	.312	17.124	.438	16.876	.562
20	20.000	19.250	.375	19.000	.500			19.500	.250	19.250	.375	19.000	.500	18.814	.593
22	22.000	21.250	.375	21.000	.500			21.500	.250	21.250	.375	21.000	.500		
24	24.000	23.250	.375	23.000	.500			23.500	.250	23.250	.375	22.876	.562	22.626	.687
26	26.000	25.250	.375	25.000	.500			25.376	.312	25.000	.500				
28	28.000	27.250	.375	27.000	.500			27.376	.312	27.000	.500	26.750	.625		
30	30.000	29.250	.375	29.000	.500			29.376	.312	29.000	.500	28.750	.625		
32	32.000	31.250	.375	31.000	.500			31.376	.312	31.000	.500	30.750	.625		
34	34.000	33.250	.375	33.000	.500			33.376	.312	33.000	.500	32.750	.625		
36	36.000	35.250	.375	35.000	.500			35.376	.312	35.000	.500	34.750	.625		
42	42.000	41.250	.375	41.000	.500					41.000	.500	40.750	.625		

Ductile Iron Pipe - Standard Classes

Size INCH	OUTSIDE DIA. INCH	Class 50		Class 51		Class 52		Class 53		Class 54		Class 55		Class 56		CEMENT LINING	
		WALL	I.D.	WALL	I.D.	WALL	I.D.	WALL	I.D.	WALL	I.D.	WALL	I.D.	WALL	I.D.	** STD THICKNESS	** DOUBLE THICKNESS
3	3.96			0.25	3.46	0.28	3.40	0.31	3.34	0.34	3.28	0.37	3.22	0.41	3.14		
4	4.80			0.26	4.28	0.29	4.22	0.32	4.16	0.35	4.10	0.38	4.04	0.44	3.93		
6	6.90	0.25	6.40	0.28	6.34	0.31	6.28	0.34	6.22	0.37	6.16	0.40	6.10	0.43	6.04	.125	.250
8	9.05	0.27	8.51	0.30	8.45	0.33	8.39	0.36	8.33	0.39	8.27	0.42	8.21	0.45	8.15		
10	11.10	0.39	10.32	0.32	10.46	0.35	10.40	0.38	10.34	0.41	10.28	0.44	10.22	0.47	10.16		
12	13.20	0.31	12.58	0.34	12.52	0.37	12.46	0.40	12.40	0.43	12.34	0.46	12.28	0.49	12.22		
14	15.30	0.33	14.64	0.36	14.58	0.39	14.52	0.42	14.46	0.45	14.40	0.48	14.34	0.51	14.28		
16	17.40	0.34	16.72	0.37	16.66	0.40	16.60	0.43	16.54	0.46	16.48	0.49	16.42	0.52	16.36		
18	19.50	0.35	18.80	0.38	18.74	0.41	18.68	0.44	18.62	0.47	18.56	0.50	18.50	0.53	18.44	.1875	.375
20	21.60	0.36	20.88	0.39	20.82	0.42	20.76	0.45	20.70	0.48	20.64	0.51	20.58	0.54	20.52		
24	25.80	0.38	25.04	0.41	24.98	0.44	24.92	0.47	24.86	0.50	24.80	0.53	24.74	0.56	24.68		
30	32.00	0.39	31.22	0.43	31.14	0.47	31.06	0.51	30.98	0.55	30.90	0.59	30.82	0.63	30.74		
36	38.30	0.43	37.44	0.48	37.34	0.62	37.06	0.58	37.14	0.63	37.04	0.68	36.94	0.73	36.84	.250	.500
42	44.50	0.47	43.56	0.53	43.44	0.59	43.32	0.65	43.20	0.71	43.08	0.77	42.96	0.83	42.84		
48	50.80	0.51	49.78	0.58	49.64	0.65	49.50	0.72	49.36	0.79	49.22	0.86	49.08	0.93	48.94		
54	57.10	0.57	55.96	0.65	55.80	0.73	55.64	0.81	55.48	0.89	55.32	0.97	55.16	1.05	55.00		

** REDUCE I. D. BY DIMENSION SHOWN

Stainless Steel, Hastelloy "C" & Titanium Pipe

Pipe Size	Pipe O.D.	Schedule 5 S (a)		Schedule 10 S (a)		Schedule 40 S		Schedule 80 S	
		I.D.	WALL	I.D.	WALL	I.D.	WALL	I.D.	WALL
1	.840	.710	.065	.674	.083	.622	.109	.546	.147
	1.050	.920	.065	.884	.083	.824	.113	.742	.154
	1.315	1.185	.065	1.097	.109	1.049	.133	.957	.179
1	1.660	1.530	.065	1.442	.109	1.380	.140	1.278	.191
1	1.900	1.770	.065	1.682	.109	1.610	.145	1.500	.200
2	2.375	2.245	.065	2.157	.109	2.067	.154	1.939	.218
2	2.875	2.709	.083	2.635	.120	2.469	.203	2.323	.276
3	3.500	3.334	.083	3.260	.120	3.068	.216	2.900	.300
3	4.000	3.834	.083	3.760	.120	3.548	.226	3.364	.318
4	4.500	4.334	.083	4.260	.120	4.026	.237	3.826	.337
5	5.563	5.345	.109	5.295	.134	5.047	.258	4.813	.375
6	6.625	6.407	.109	6.357	.134	6.065	.280	5.761	.432
8	8.625	8.407	.109	8.329	.148	7.981	.322	7.625	.500
10	10.750	10.482	.134	10.420	.165	10.020	.365	9.750	.500
12	12.750	12.438	.156	12.390	.180	12.000	.375	11.750	.500
14	14.000	13.688	.156	13.624	.188				
16	16.000	15.670	.165	15.624	.188				
18	18.000	17.670	.165	17.624	.188				
20	20.000	19.634	.188	19.564	.218				
22	22.000	21.624	.188	21.564	.218				
24	24.000	23.563	.218	23.500	.250				

Pipe Size	Pipe O.D.	Schedule 60		Schedule 80		Schedule 100		Schedule 120		Schedule 140		Schedule 160	
		I.D.	WALL	I.D.	WALL	I.D.	WALL	I.D.	WALL	I.D.	WALL	I.D.	WALL
1	.840			.546	.147							.466	.187
	1.050			.742	.154							.614	.218
	1.315			.957	.179							.815	.250
1	1.660			1.278	.191							1.160	.250
1	1.900			1.500	.200							1.338	.281
2	2.375			1.939	.218							1.689	.343
2	2.875			2.323	.276							2.125	.375
3	3.500			2.900	.300							2.624	.438
3	4.000			3.364	.318								
4	4.500			3.826	.337			3.624	.438			3.438	.531
5	5.563			4.813	.375			4.563	.500			4.313	.625
6	6.625			5.761	.432			5.501	.562			5.189	.718
8	8.625	7.813	.406	7.625	.500	7.439	.593	7.189	.718	7.001	.812	6.813	.906
10	10.750	9.750	.500	9.564	.593	9.314	.718	9.064	.843	8.750	1.000	8.500	1.125
12	12.750	11.626	.562	11.376	.687	11.064	.843	10.750	1.000	10.500	1.125	10.126	1.312
14	14.000	12.814	.593	12.500	.750	12.126	.937	11.814	1.093	11.500	1.250	11.188	1.406
16	16.000	14.688	.656	14.314	.843	13.938	1.031	13.564	1.218	13.124	1.438	12.814	1.593
18	18.000	16.500	.750	16.126	.937	15.688	1.156	15.250	1.375	14.876	1.562	14.438	1.781
20	20.000	18.376	.812	17.938	1.031	17.438	1.281	17.000	1.500	16.500	1.750	16.064	1.968
22	22.000	20.250	.875	19.750	1.125	19.250	1.375	18.750	1.625	18.250	1.875	17.750	2.125
24	24.000	22.064	.968	21.564	1.218	20.938	1.531	20.376	1.812	19.876	2.062	19.314	2.343

Cast Iron Pipe - ASA Standard

Pipe Size	Pipe O.D.	Class 50		Class 100		Class 150		Class 200		Class 250		Class 300		Class 350	
		WALL	I.D.	WALL	I.D.	WALL	I.D.	WALL	I.D.	WALL	I.D.	WALL	I.D.	WALL	I.D.
3	3.96	0.32	3.32	0.32	3.32	0.32	3.32	0.32	3.32	0.32	3.32	0.32	3.32	0.32	3.32
4	4.80	0.35	4.10	0.35	4.10	0.35	4.10	0.35	4.10	0.35	4.10	0.35	4.10	0.35	4.10
6	6.90	0.38	6.14	0.38	6.14	0.38	6.14	0.38	6.14	0.38	6.14	0.38	6.14	0.38	6.14
8	9.05	0.41	8.23	0.41	8.23	0.41	8.23	0.41	8.23	0.41	8.23	0.41	8.23	0.41	8.23
10	11.10	0.44	10.22	0.44	10.22	0.44	10.22	0.44	10.22	0.44	10.22	0.48	10.14	0.52	10.06
12	13.20	0.48	12.24	0.48	12.24	0.48	12.24	0.48	12.24	0.52	12.16	0.52	12.16	0.56	12.08
14	15.30	0.48	14.34	0.51	14.28	0.51	14.28	0.55	14.20	0.59	14.12	0.59	14.12	0.64	14.02
16	17.40	0.54	16.32	0.54	16.32	0.54	16.32	0.58	16.24	0.63	16.14	0.68	16.04	0.68	16.04
18	19.50	0.54	18.42	0.58	18.34	0.58	18.34	0.63	18.24	0.68	18.14	0.73	18.04	0.79	17.92
20	21.60	0.57	20.46	0.62	20.36	0.62	20.36	0.67	20.26	0.72	20.16	0.78	20.04	0.84	19.92
24	25.80	0.63	24.54	0.68	24.44	0.73	24.34	0.79	24.22	0.79	24.22	0.85	24.10	0.92	23.96

Cast Iron Pipe - AWWA Standard

Pipe Size	Class A 100 Ft. 43 PSIG			Class B 200 Ft. 86 PSIG			Class C 300 Ft. 130 PSIG			Class D 400 Ft. 173 PSIG		
	O.D.	WALL	I.D.	O.D.	WALL	I.D.	O.D.	WALL	I.D.	O.D.	WALL	I.D.
3	3.80	0.39	3.02	3.96	0.42	3.12	3.96	0.45	3.06	3.96	0.48	3.00
4	4.80	0.42	3.96	5.00	0.45	4.10	5.00	0.48	4.04	5.00	0.52	3.96
6	6.90	0.44	6.02	7.10	0.48	6.14	7.10	0.51	6.08	7.10	0.55	6.00
8	9.05	0.46	8.13	9.05	0.51	8.03	9.30	0.56	8.18	9.30	0.60	8.10
10	11.10	0.50	10.10	11.10	0.57	9.96	11.40	0.62	10.16	11.40	0.68	10.04
12	13.20	0.54	12.12	13.20	0.62	11.96	13.50	0.68	12.14	13.50	0.75	12.00
14	15.30	0.57	14.16	15.30	0.66	13.98	15.65	0.74	14.17	15.65	0.82	14.01
16	17.40	0.60	16.20	17.40	0.70	16.00	17.80	0.80	16.20	17.80	0.89	16.02
18	19.50	0.64	18.22	19.50	0.75	18.00	19.92	0.87	18.18	19.92	0.96	18.00
20	21.60	0.67	20.26	21.60	0.80	20.00	22.06	0.92	20.22	22.06	1.03	20.00
24	25.80	0.76	24.28	25.80	0.89	24.02	26.32	1.04	24.22	26.32	1.16	24.00
30	31.74	0.88	29.98	32.00	1.03	29.94	32.40	1.20	30.00	32.74	1.37	30.00
36	37.96	0.99	35.98	38.30	1.15	36.00	38.70	1.36	39.98	39.16	1.58	36.00
42	44.20	1.10	42.00	44.50	1.28	41.94	45.10	1.54	42.02	45.58	1.78	42.02
48	50.50	1.26	47.98	50.80	1.42	47.96	51.40	1.71	47.98	51.98	1.96	48.06
54	56.66	1.35	53.96	57.10	1.55	54.00	57.80	1.90	54.00	58.40	2.23	53.94
60	62.80	1.39	60.02	63.40	1.67	60.06	64.20	2.00	60.20	64.82	2.38	60.06
72	75.34	1.62	72.10	76.00	1.95	72.10	76.88	2.39	72.10			
84	87.54	1.72	84.10	88.54	2.22	84.10						

Pipe Size	Class E 500 Ft. 217 PSIG			Class F 600 Ft. 260 PSIG			Class G 700 Ft. 304 PSIG			Class H 800 Ft. 347 PSIG		
	O.D.	WALL	I.D.	O.D.	WALL	I.D.	O.D.	WALL	I.D.	O.D.	WALL	I.D.
6	7.22	0.58	6.06	7.22	0.61	6.00	7.38	0.65	6.08	7.38	0.69	6.00
8	9.42	0.66	8.10	9.42	0.71	8.00	9.60	0.75	8.10	9.60	0.80	8.00
10	11.60	0.74	10.12	11.60	0.80	10.00	11.84	0.86	10.12	11.84	0.92	10.00
12	13.78	0.82	12.14	13.78	0.89	12.00	14.08	0.97	12.14	14.08	1.04	12.00
14	15.98	0.90	14.18	15.98	0.99	14.00	16.32	1.07	14.18	16.32	1.16	14.00
16	18.16	0.98	16.20	18.16	1.08	16.00	18.54	1.18	16.18	18.54	1.27	16.00
18	20.34	1.07	18.20	20.34	1.17	18.00	20.78	1.28	18.22	20.78	1.39	18.00
20	22.54	1.15	20.24	22.54	1.27	20.00	23.02	1.39	20.24	23.02	1.51	20.00
24	26.90	1.31	24.28	26.90	1.45	24.00	27.76	1.75	24.26	27.76	1.88	24.00
30	33.10	1.55	30.00	33.46	1.73	30.00						
36	39.60	1.80	36.00	40.04	2.02	36.00						